

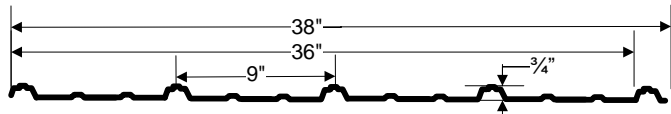

# STEEL ROOFING

## PERFORMANCE PANEL DETAIL MANUAL



PERFORMANCE PANEL (P)  
28 GA

FOR METAL ROOFING SYSTEMS  
FASCIA, MANSARDS, & SOFFITS  
WALL PANELS/SIDING

HIGGINS CONSTRUCTION & SUPPLY CO.  
3801 U. S. 50 HILLSBORO, OHIO 45133  
1-800-782-4239 937-364-2331 FAX 937-364-2333  
[www.higginsroofing.com](http://www.higginsroofing.com)

## HIGGINS CONSTRUCTION & SUPPLY CO.

The details contained in the following pages are guidelines as to how our product can be installed. While we believe all information presented is accurate, it is not intended to cover all instances, building requirements, designs or codes. The details may require adaptations, changes, or revisions for each project since conditions may vary from one project to another and may be unique for each application.

The details shown are widely used methods of construction. It must be noted that weather tightness through the use of these details, good materials and workmanship, and adequate sealants must be used.

It is the responsibility of the designer/roofing contractor /installer to ensure that the enclosed details are adapted to meet particular building requirements and to assure adequate weather tightness. The designer/installer must be aware of and allow for expansion/contraction of panels when designing and/or installing panels and flashing.

In like manner, ensuring adequacy of anchoring framing materials to walls, structures, sub girts, and cees/zees, shall be determined by the designer/installer. The installer should familiarize themselves with all erection instructions before starting work.

Before beginning erection of panels, the installer shall examine the substrate to ensure that all supporting members are straight, level, plumb, and true in accordance with minimum tolerances. Report any variations and potential problems to the architect. Do not start work until unsatisfactory conditions have been corrected.

The roofing/fascia/wall system shall be installed plumb, straight, and true to adjacent work. Seams shall be equal distance from corners, hips, mullions, columns, etc., in accordance with design concept as shown on the drawings. Proper spacing should be allowed between panels/trim so that none are in standing water. Closed cell rubber closures shall be embedded in sealant.

Installation procedures, which are not indicated, shall be in accordance with the SMACNA details. Flashing and trim shall be installed true and in proper alignment, with any exposed fasteners equally spaced for best appearance.

Sealants for joints and flashing end caps shall be non-drying, non-toxic, non-shrinking, and shall have a serviceable temperature of -50 to 212 degrees F. Sealant shall be field applied on dry, clean surfaces. To ensure weather tightness, the sealant shall be installed where indicated without skips or voids.

The installer may utilize details provided and procedures recommended for installation of materials. Some field cutting and fitting of panels and flashing is expected of the installer and field corrections of materials are a part of normal erection work, Workmanship shall be the best industry standards and installation shall be performed by experienced craftsmen.

SMACNA(Sheet Metal and Air Conditioning Contractors National Association) architectural sheet metal manual specifications shall govern for material and workmanship not shown.

## **Panel Storage**

Moisture on the panels can cause damage to the finish. Always store in a dry location. If panels get wet, separate the sheets and allow them to dry completely before restacking.

## **Cutting Steel Panels**

Cut panels with snips, shears or nibblers. Never use a metal or abrasive blade to cut panels. These blades will burn the coating on the steel. This will cause the panel to rust.

## **Drilling Panels**

Pre drilling panels for uniform fastener alignment is acceptable as long as all filings are removed.

## **Pressure Treated Lumber**

When Galvalume or Galvanized steel is used in conjunction with Pressure treated lumber the steel must have a protective barrier between the treated lumber and the steel. For example: (Felt paper)

In addition to the protective barrier, stainless steel or other special treated fasteners for use with pressure treated wood must be used

## **Corrosive Environments**

There are many corrosive chemicals and substances that will cause deterioration of steel panels. Some examples of materials to avoid contact with are copper, including copper bearing chemicals, water drainage from copper pipes such as air conditioning units and animal waste. Iron, including iron debris and saw fines left over from cutting steel panels. Graphite including pencil marks and lead. Caution should be taken to ensure contact with any corrosive product is avoided.

## **Residential installations**

Solid decking is recommended for all residential applications. When installing a residential roof always use 30 lb felt or a synthetic underlayment.

## **Unpainted Galvalume and Galvanized panel**

Unpainted bare Galvalume and Galvanized panels will have different appearance coil to coil and will change color unevenly. If you require a uniform color for your project, painted coil must be used!

## **Performance Panel Steel Specifications before paint**

ASTM A924, which allows magnetic, isotope and x-ray in addition to the weight-strip- weigh method for coating weight test procedures

ASTM A792-10 Gr 80 Class 1 Approved Ss Extra Smoth C .20 Max Mn 1.35 Max P .04 Max S .040 Maz Cu .25 Max Ni .20 Max Cr .15 Max Mo .06 Maz V .008 Max TI .025 Max Cb .015 Maz Exposed Prime Side Out AZ50 Chem Treat Dry Ys Min 80 Ksi .2% Offset Ts Min 82 Ksi EL Dist 2 Inches Longitudinal Astm Std Tens

## **Trim Steel Specifications before paint**

ASTM A792-10 Approved Cs Type B Extra Smooth C .02/.15 Mn .60 Max P .030 Max S .035 Max CU .25 Max CR .15 Max Mo .06 Max V .008 Max Ti .025 Max Cb .008 Max Exposed Prime Side Out AZ50 Chem Treat Dry.

## **Paint Specifications**

Akzo Nobel, Ceram-A-Star 1050, Cool Chemistry series paint. It is a 40 year warranted paint systems and all Performance Panel colors have been Energy Star qualified since 2009. See [www.higginsroofing.com](http://www.higginsroofing.com) for updated information or find updated information at [www.energystar.gov](http://www.energystar.gov). Under certified roofing products.



Quality assurance for Performance Panel, Energy Star qualified paint systems, are administered by Keystone Certifications Inc. Keystone is an EPA recognized Certification Body.

## **Fasteners Specifications**

Steel to wood fasteners shall be Wood Binders or long life Wood Binder ZXL

Wood Binder - Powder Coated, Zinc Plating and Chromate Sealed - ¼" HWH - 30 Degree Type 17 sharp point - Major Diameter .210/.200 - Minor Diameter .130..126 – Bonded Washer Diameter .472 – Head Across Flats .247/.244 – Ult. Tensile Strength 1904 LBS – Min. Torsional strength 60 IN-LBS Nom. Shear Strength 1547 LBS

**PULL OUT STRENGTH****LBS. ULT.**

SUBSTRATE	PENETRATION	VALUE
3/4" PLY		707
5/8" PLY		590
1/2" PLY		400
7/16" OSB		310
2 X Y.PINE*	1"	1052
2 X Y.PINE*	FULL	1552
2 X SPF*	1"	492
2 X SPF*	FULL	1042
2 X OAK	1"	1894

\* Y.PINE (Yellow Pine) \* SPF (Spruce Pine Fir)

**PULL OVER STRENGTH****LBS. ULT.**

SUBSTRATE	GAUGE	THICKNESS	VALUE
AZ55 Galvalume	29	.015	378
AZ55 Galvalume	26	.019	629
AZ55 Galvalume	24	.024	721

**Wood Binder ZXL**

Wood Binder ZXL, 5/16 cupped HWH with a molded ZAAMAC 5 Zinc-Aluminum alloy, 30 degree type 17 head, Major Diameter .210/.200, Minor Diameter .130/.126, Washer diameter .500, UTL. Tensile Strength 1585 lbs, Min. Torsional Strength 60 IN-LBS, Nom. Shear Strength 1574 LBS.

**PULL OUT STRENGTH****LBS. ULT.**

SUBSTRATE	PENETRATION	VALUE
3/4" PLY		707
5/8" PLY		591
1/2" PLY		400
7/16" OSB		310
2 X Y.PINE*	1"	1052
2 X Y.PINE*	FULL	1552
2 X SPF*	1"	492
2 X SPF*	FULL	1042
2 X OAK	1"	1585

**PULL OVER STRENGTH****LBS. ULT.**

SUBSTRATE	GAUGE	THICKNESS	VALUE
AZ55 Galvalume	29	.015	658
AZ55 Galvalume	26	.019	927
AZ55 Galvalume	24	.024	1035
AZ55 Galvalume	22	.032	1386

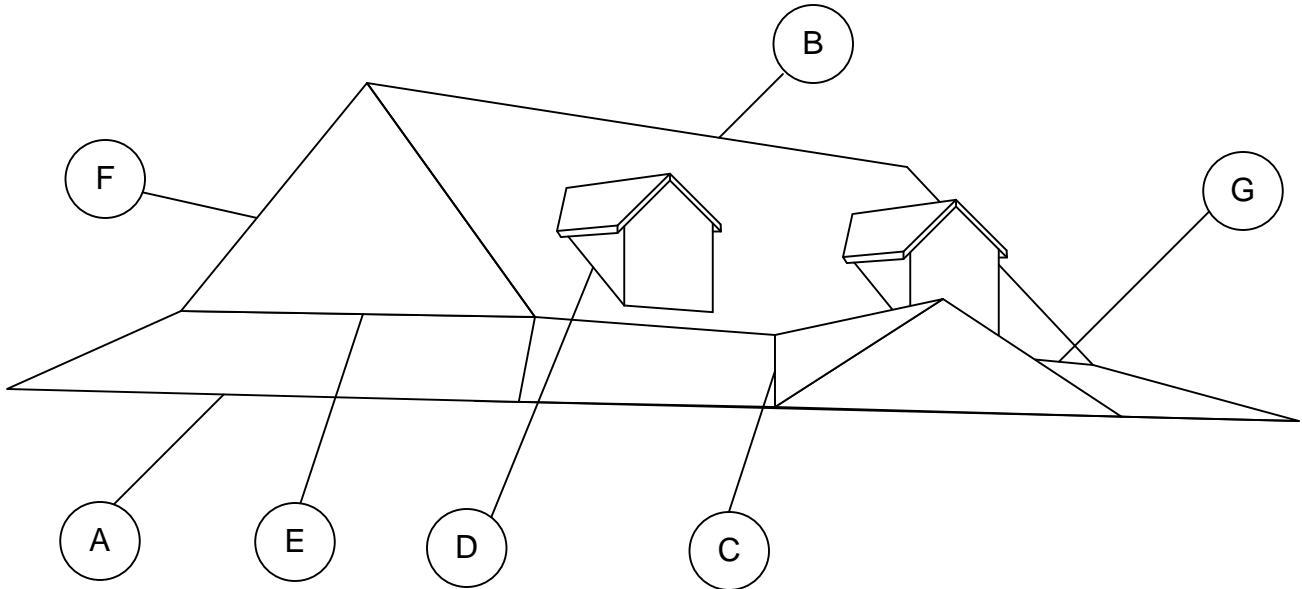

### CONSTRUCTION DETAILS LOCATION

A. EAVE DETAIL PG. 2

B. RIDGE DETAIL PG. 3

C. VALLEY DETAIL PG. 4

D. SIDEWALL DETAIL PG. 5

E. ENDWALL DETAIL PG. 6

F. RAKE DETAIL PG. 7

G. TRANSITION DETAIL PG. 8

Ridge application

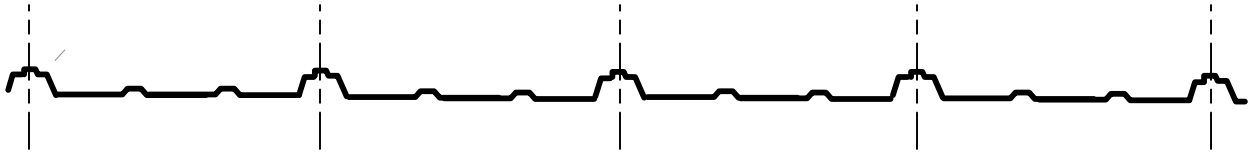

Screws

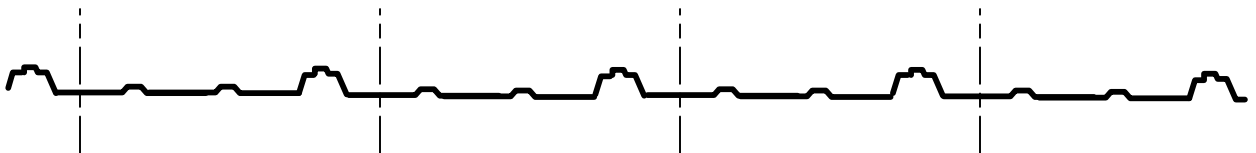

Nails or Screws

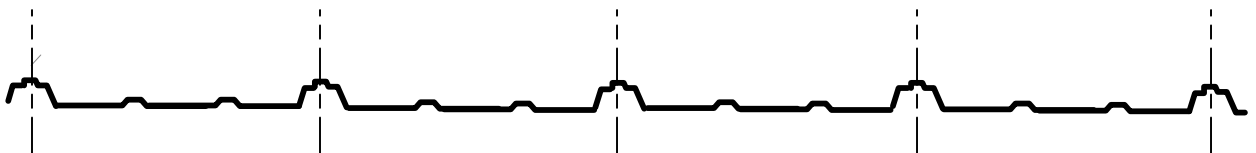

High Wind Application or Endlap Screws

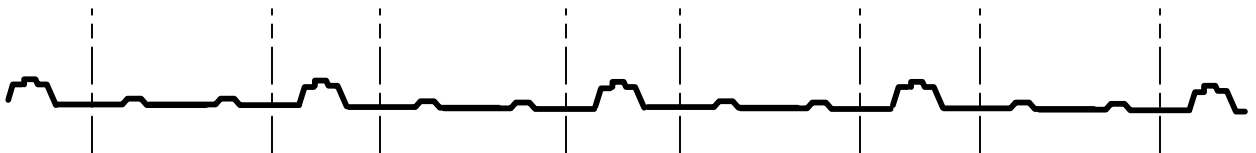

# PROFILE

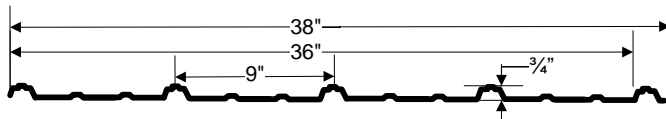

PERFORMANCE PANEL (P)  
28 GA

# Overlap

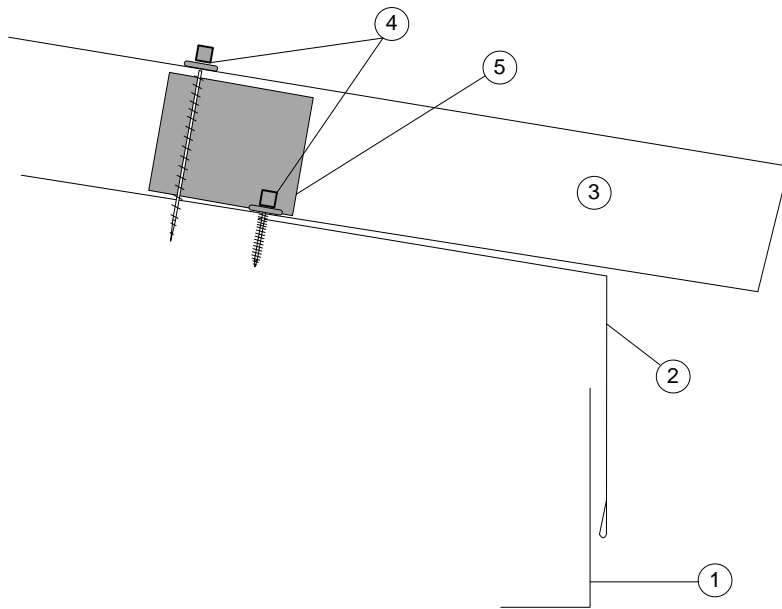
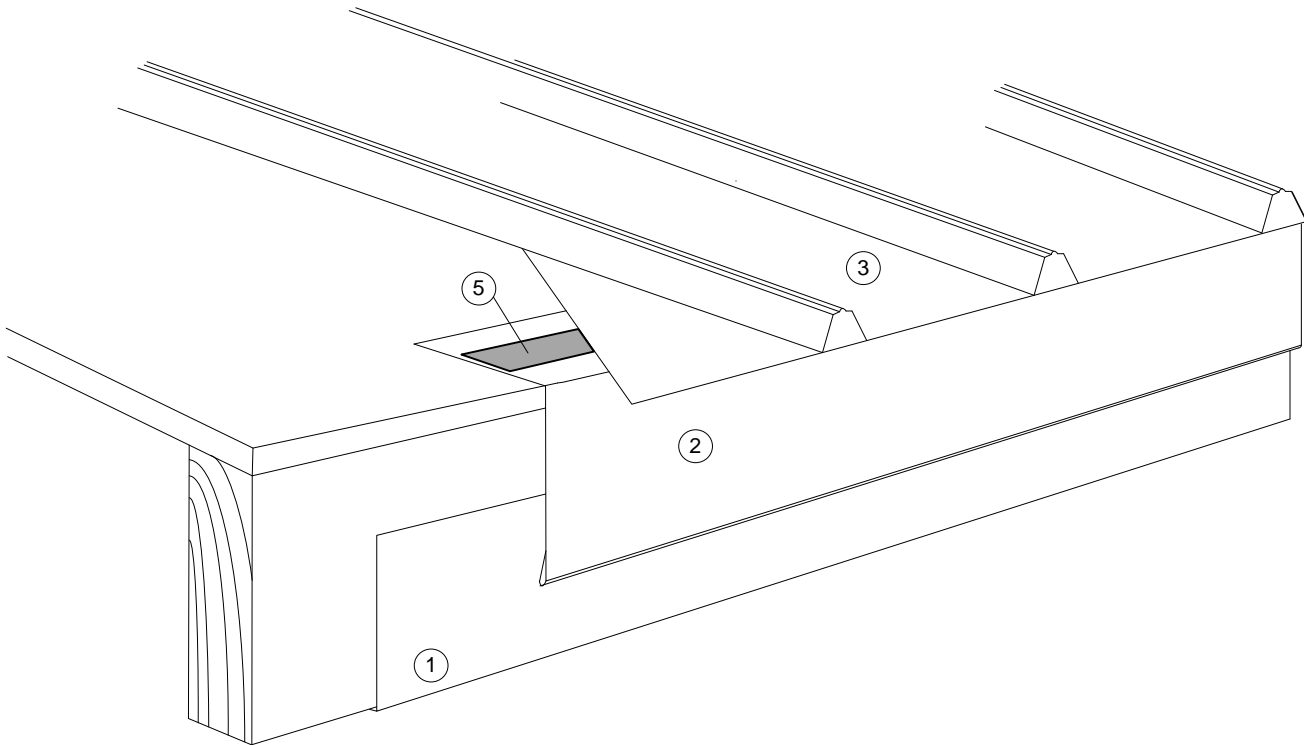

1	POST TRIM
2	DRIP EDGE
3	ROOF PANEL
4	SCREW
5	FOAM CLOSURE
6	
7	



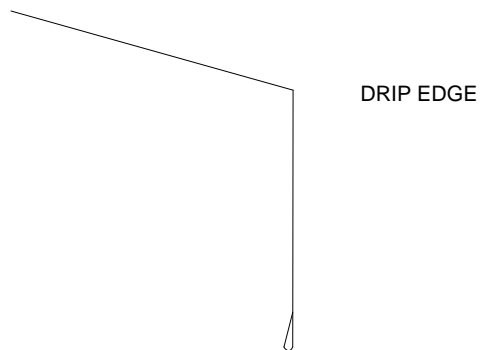
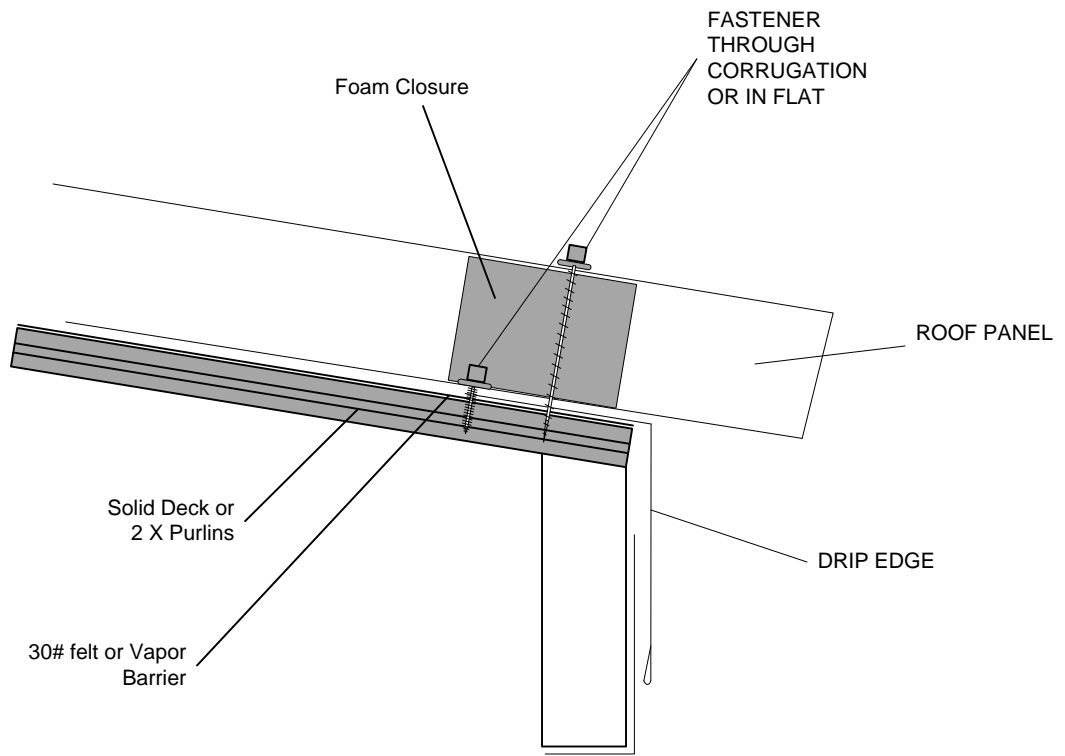

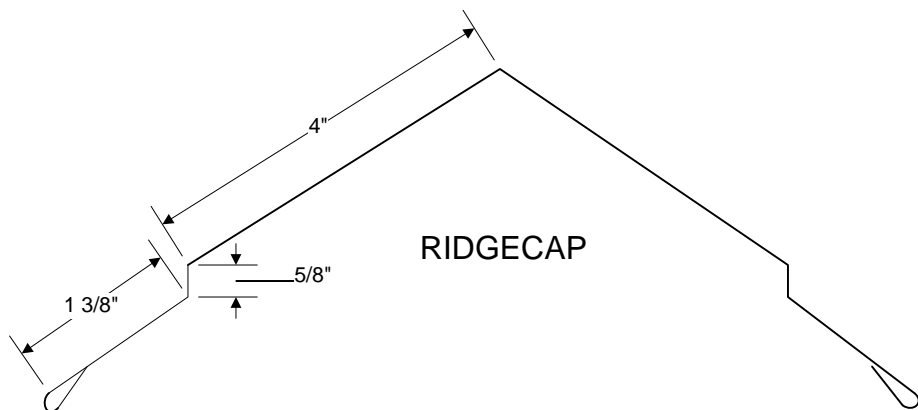
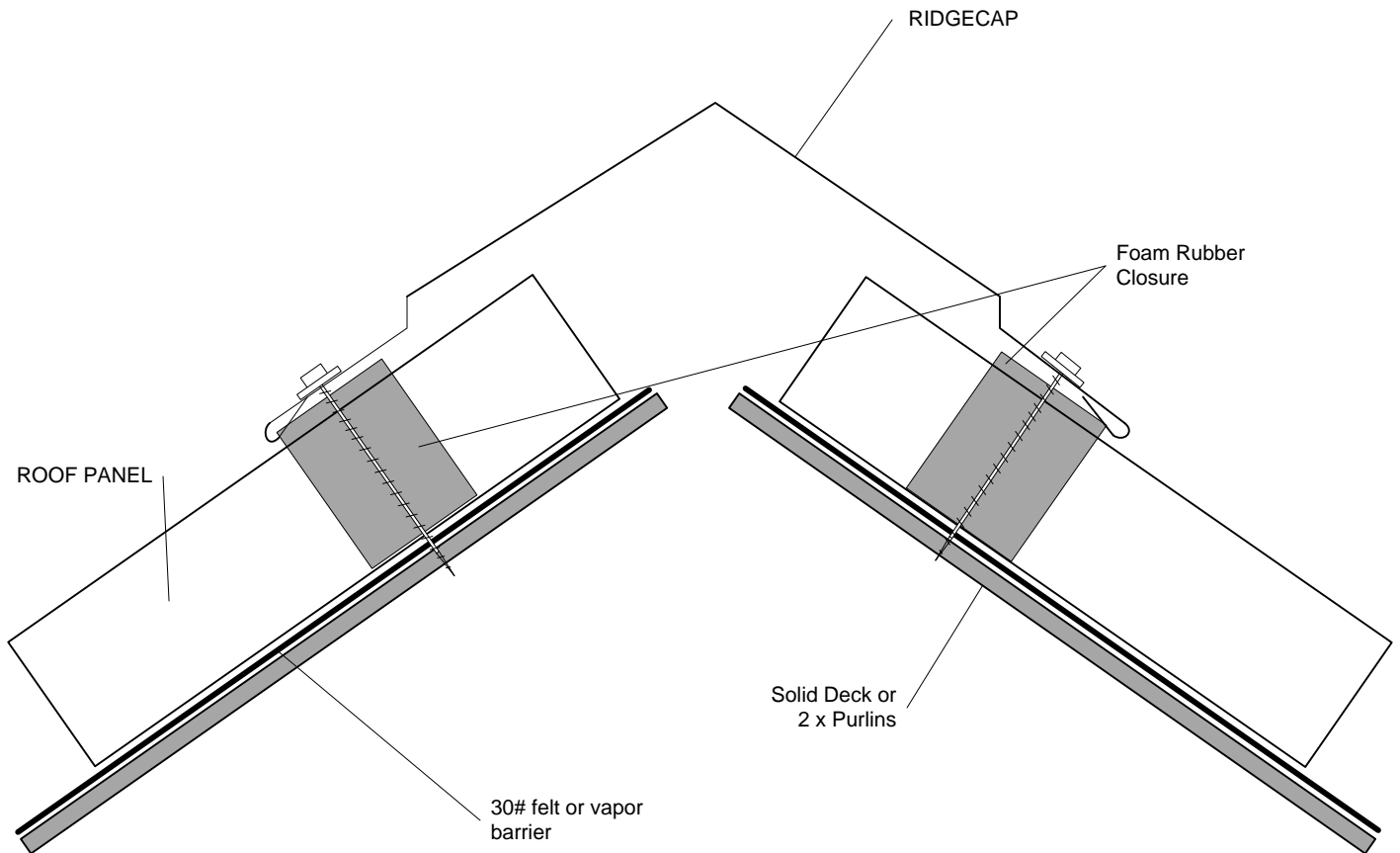

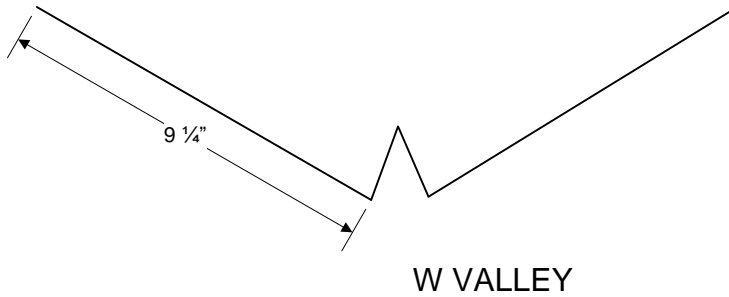
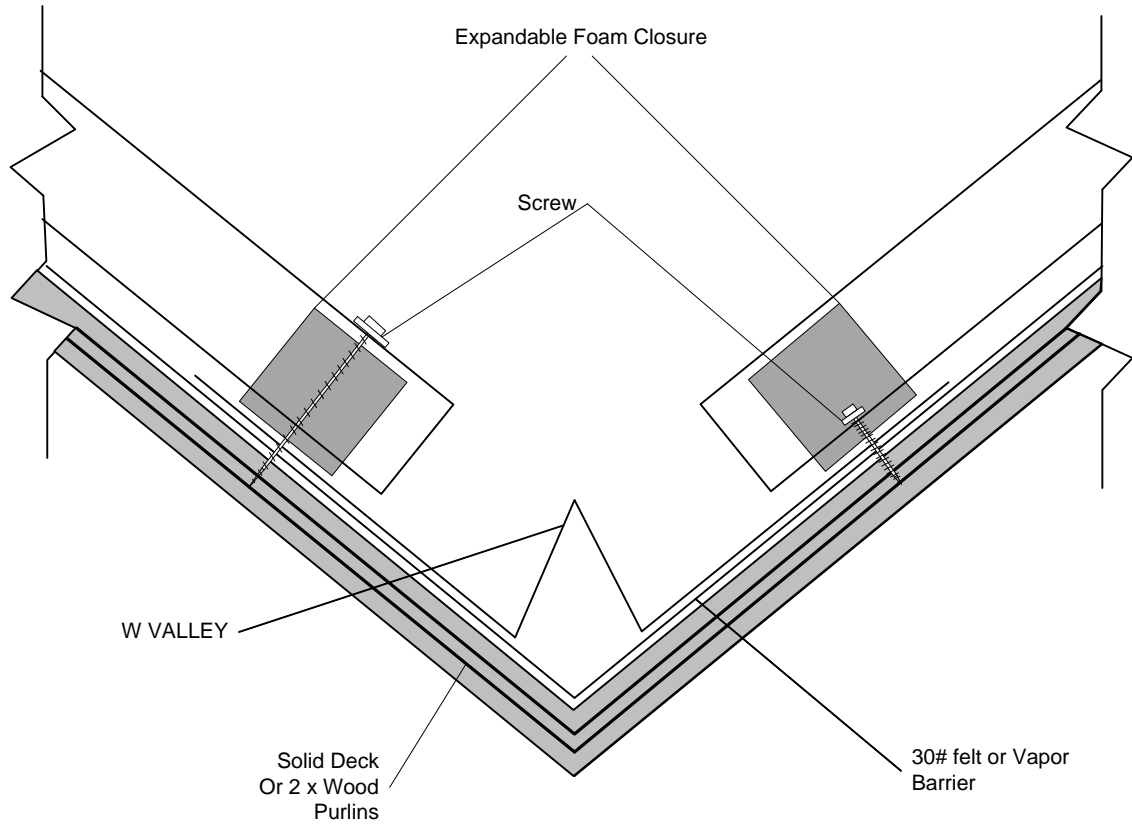

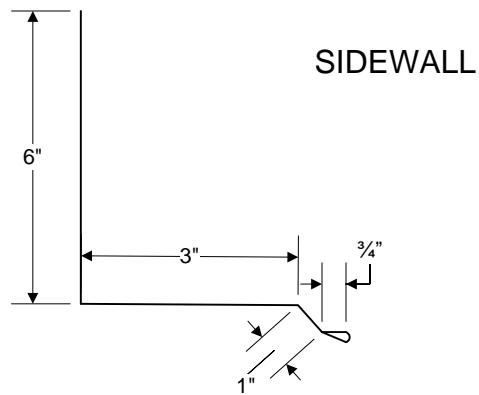
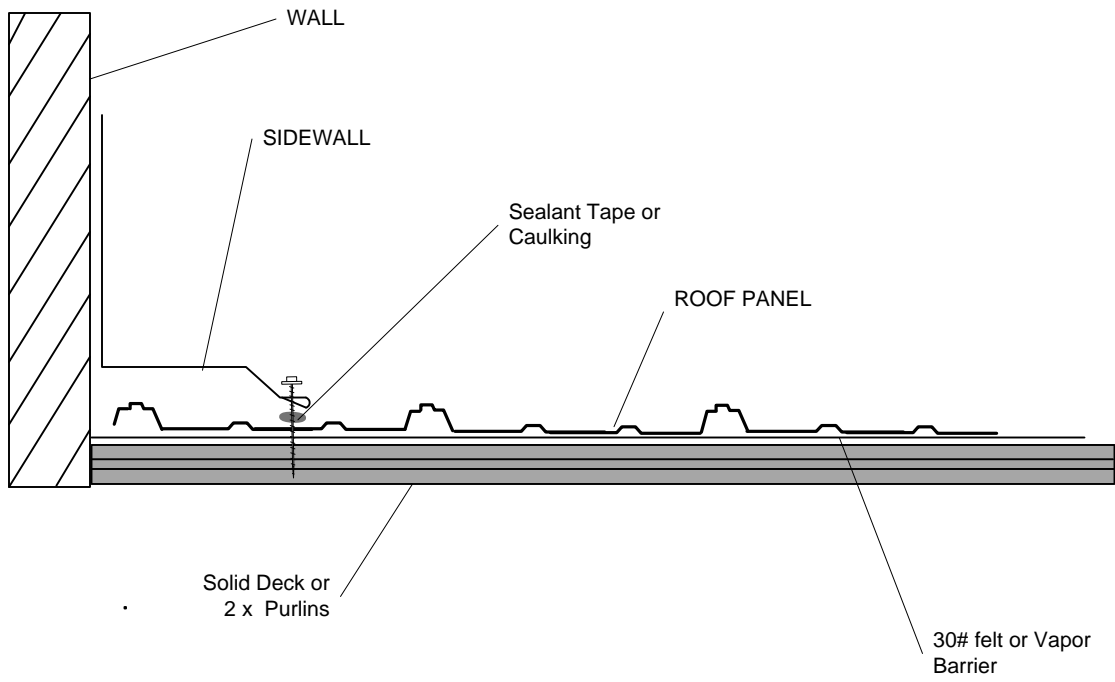

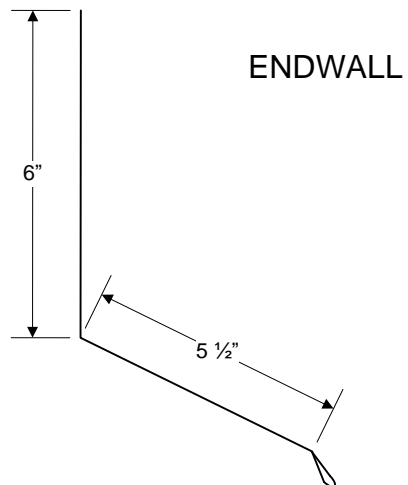
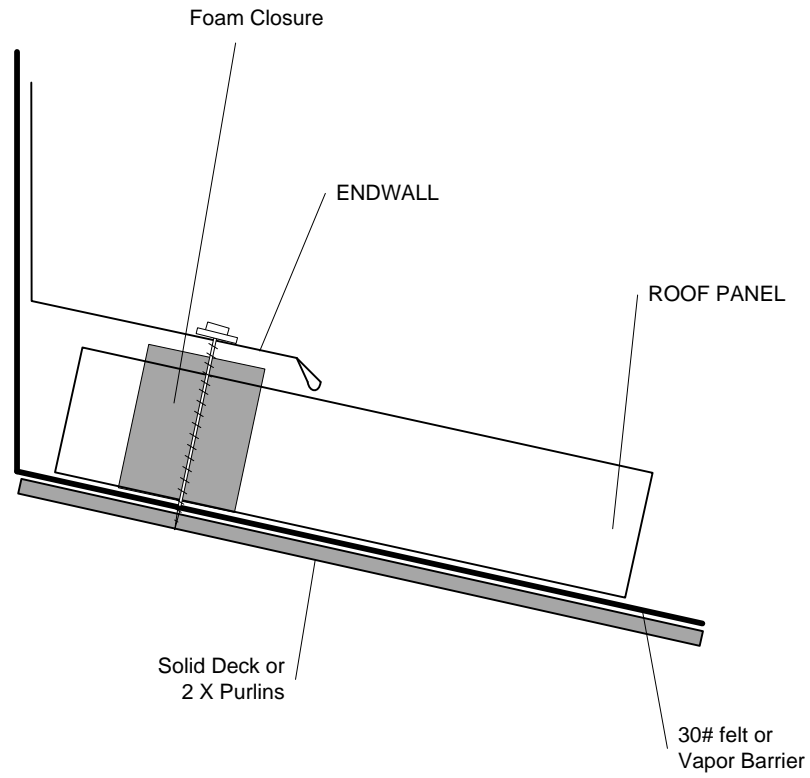

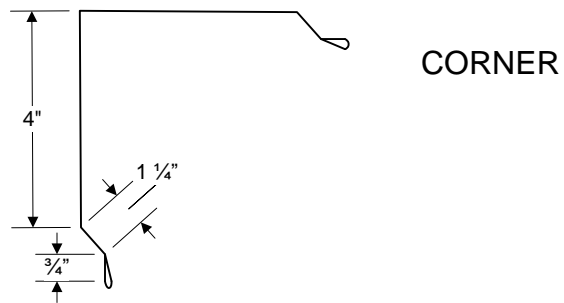
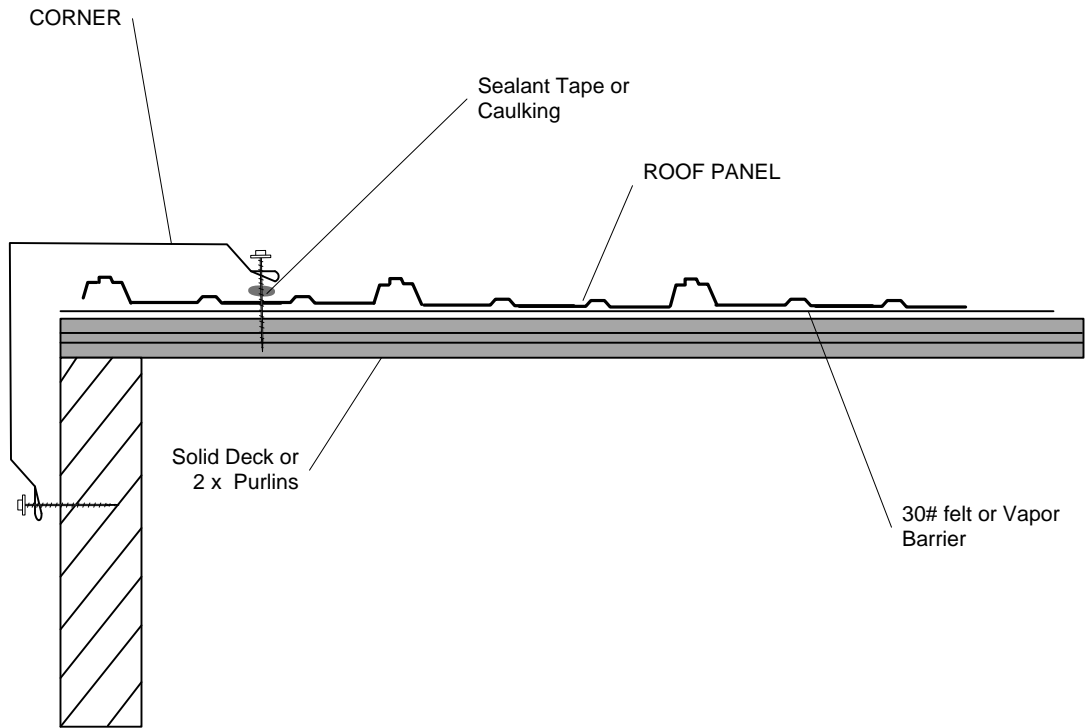

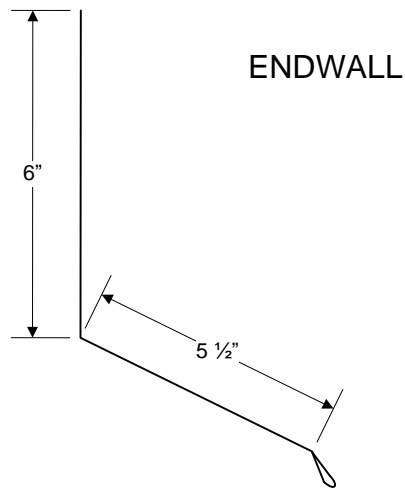
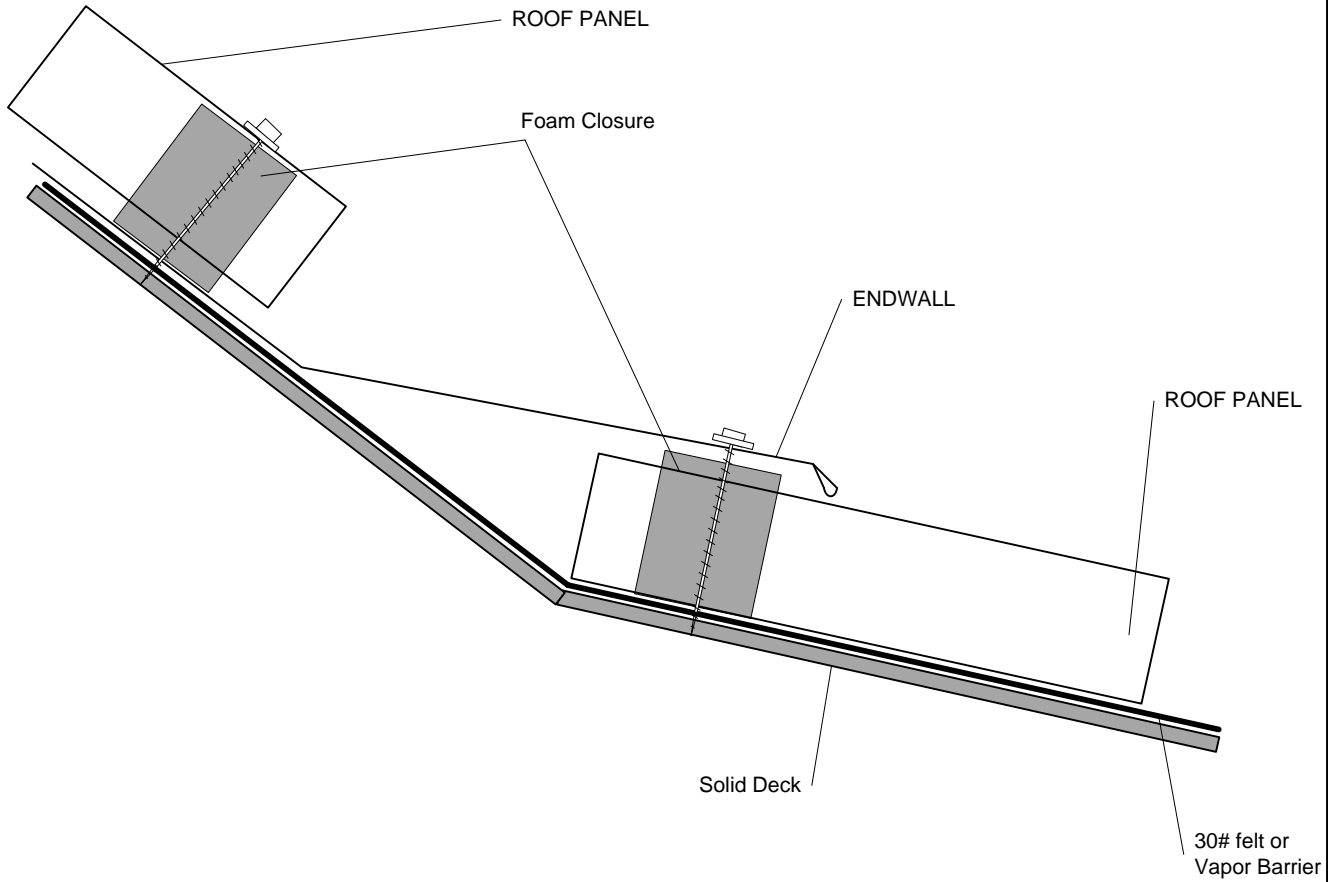

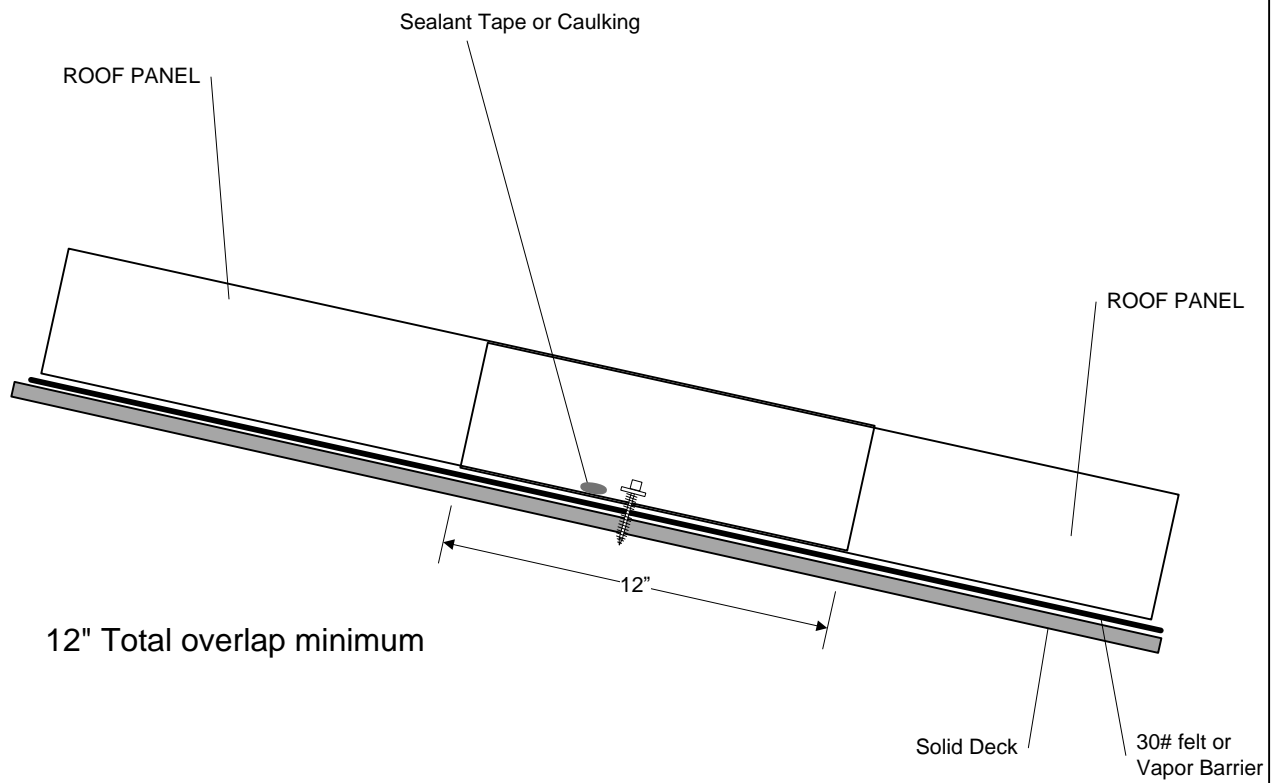



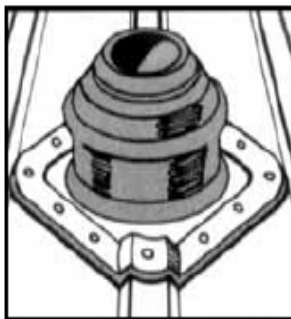

**NOTE:**  
For more effective drainage, always fit the Dektite on the diamond or bias.

Dektites are suitable for flashing pipes that penetrate wall claddings.

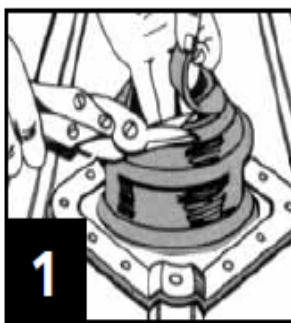
**1**

Cut a neat hole in roofing sheet with clearance for pipe and insert pipe through hole. Trim the cone to suit pipe size using sharp tin snips. Where required, support cut sections of sheet with additional framing.

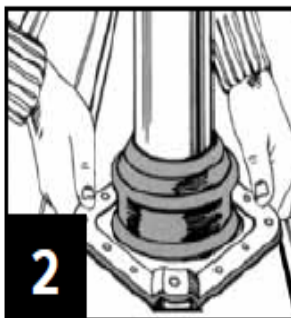
**2**

Slide Dektite flashing down over pipe. Lubricating the pipe with water allows the pipe to slide snugly into position.

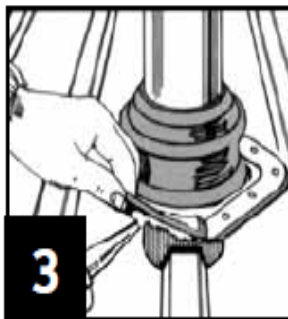
**3**

Apply a neutral-cure silicone sealant by turning back the flexible flange. The following silicones have been trialled and provided a suitable bond:

- OCI Roof & Gutter N-192
- Selleys roff & Gutter
- Bostik Findley Roof & Gutter
- Dow Corning 791
- Sikasil AP Multi Purpose

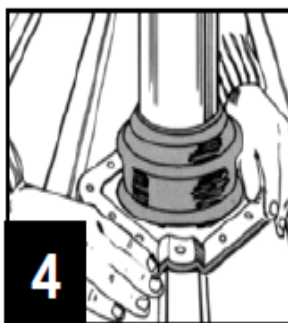
**4**

Press base to the roof profile by hand, smooth out any awkward creases. Don't fully extend to allow for vibration.

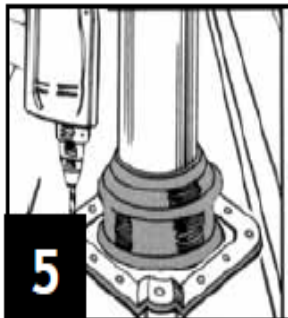
**5**

Fasten using self drilling washered screws or sealed rivets. Fit fasteners progressively outward in opposing pairs to avoid gaps.